

Highbay PIR Sensor – DALI/DSI Direct Dim

Ceiling PIR HS presence detector – DALI / DSI dimming

Overview



The EBDHS-DD PIR (passive infrared) presence detector provides automatic control of lighting loads with optional manual control. The EBDHS-DD is a high sensitivity PIR detector suitable for high bay applications, such as warehouses and factories, and where high detection sensitivity is needed

Output Channel 1 comprises a mains voltage relay capable of simple on/off switching, while Output Channel 2 provides dimmable control of either DALI or DSI type ballasts.

Functioning as a presence detector, the unit can turn lights on when a room is occupied and off when the room is empty. Optional settings allow lights to be turned off in response to ambient daylight, or to implement a maintained illuminance (daylight harvesting) system.

The flexibility of having two channels and two switch inputs allows the following example scenarios:

- Dim an outside row of luminaires whilst internal fittings are switched
- Provide absence detection for two separate channels
- Maintained illuminance system with manual up/down controls

All functionality is fully programmable using an IR handset.

Features

Front features

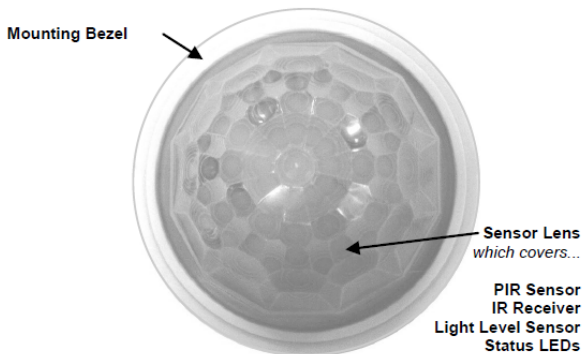

PIR Sensor

Detects movement within the unit's detection range, allowing load control in response to changes in occupancy.

IR Receiver



Receives control and programming commands from an IR (infrared) handset.

Light Level Sensor

Measures the overall light level in the detection area

Status LEDs

The LED flashes Red to indicate the following:

Walk Test LED active	 when movement is detected
Valid setting received	

Back features

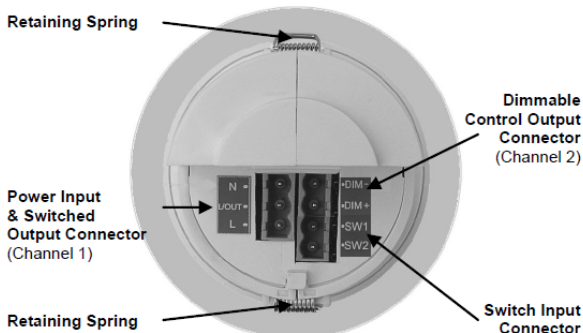

Power Input & Switched Output Connector (Channel 1)

Used to connect mains power to the unit and to connect a switched load.

Dimmable Control Output Connector (Channel 2)

Used to connect DSI/DALI controllable ballasts and transformers for dimmable loads.

Switch Input Connector

Two input terminals can be used to manually override the dimming levels and override the lights on or off

Detection diagrams

Range

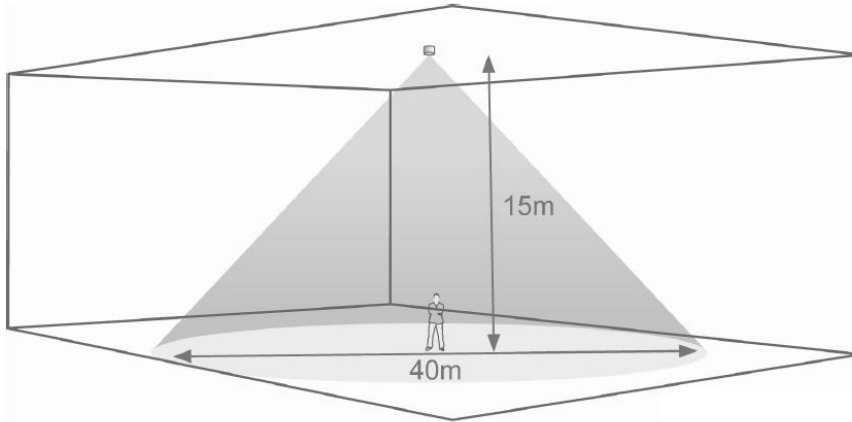

Maximum mounting height 20m

Detection pattern

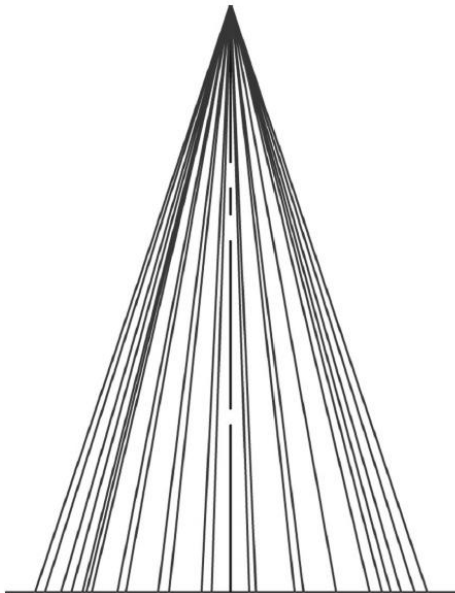

Walk across

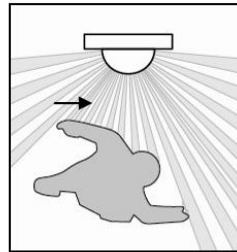

Height	Range Diameter
15m	40m
10m	26m
6m	16m
3m	9m

Walk towards

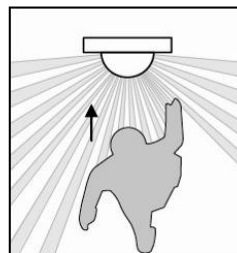

Height	Range Diameter
15m	30m
10m	20m
6m	12m
3m	8m

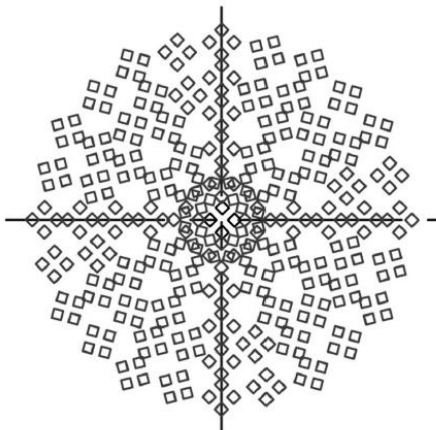

Alignment marks

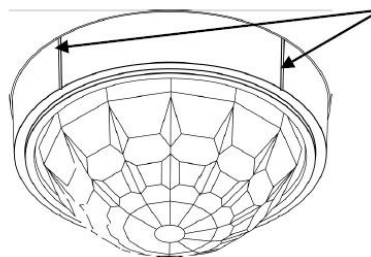

The sensor head has 4 alignment marks. These correspond to the 4 outer passive infrared sensors under the lens. Use these marks to align with aisles and corridors to ensure the best detection characteristics. See example overleaf.

Applications

Masking

The Highbay PIR includes two clip-on masking shields to allow for precise masking of the detection shape. The masks can be easily shaped to produce detection patterns suitable for applications such as aisles and corners and for narrowing the detection diameter.

Important note. Ensure all infra-red (IR) programming is completed before affixing the masking shields to the detector.

The masking shields may impair the light sensor and IR sensors by covering them. Ensure correct operation before completing commissioning.

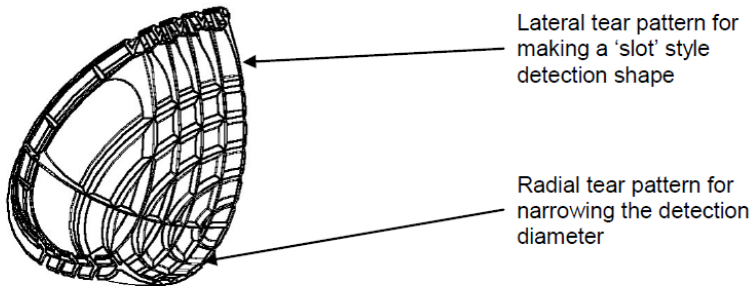

Aisles

Masking shields trimmed for aisle shaped detection

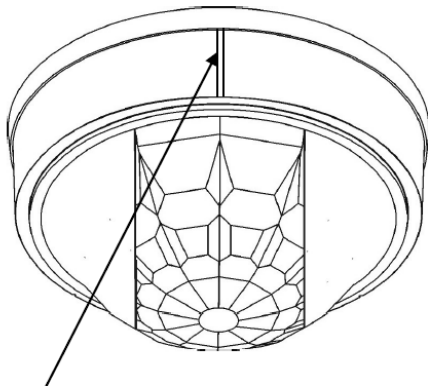

Align trimmed shields with sensor head alignment marks and aisle.

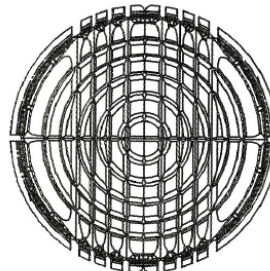

Slot number 1 2 3 4 4 3 2 1

Slot number	Masking shield % coverage
1	45%
2	32%
3	22%
4	11%

Example

Mounting height 6m
 Trimmed to slots 2
 Aisle detection width 16m x 32% = 5.1m walk across
 12m x 32% = 3.8m walk towards

Narrow detection

Masking shields trimmed for a narrow beam of detection

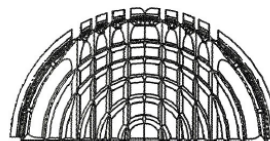
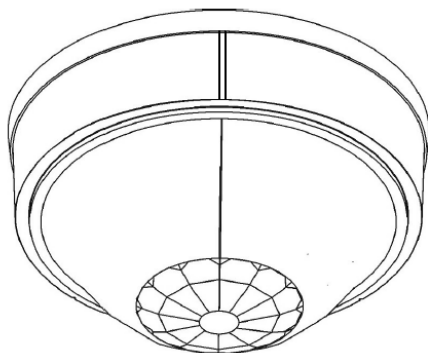

Diameter number 1 2 3 4 5 5 4 3 2 1

Diameter number	Masking shield % coverage
1	89%
2	63%
3	45%
4	32%
5	22%

Example

Mounting height 15m
 Trimmed to diameter 3
 Detection diameter 40m x 45% = 18m walk across
 30m x 45% = 13.5m walk towards

Installation

Choosing a Suitable Location

The Highbay PIR is designed to be ceiling mounted and must satisfy the following criteria:

- Avoid positioning the unit where direct sunlight may enter the sensor element.
- Do not site the sensor within 1m of any lighting, forced air heating or ventilation.
- Do not fix the sensor to an unstable or vibrating surface.

Sensor functionality

Detection Mode

The Detection Mode for both output Channels 1 and 2 can be set to behave in Presence or Absence mode:

- **Presence** When movement is detected the load will automatically turn on. When the area is no longer occupied the load will automatically switch off after an adjustable time period.
- **Absence** The load is manually switched on. When the area is no longer occupied the load will automatically switch off after the adjustable time period has elapsed.

In either case, sensitivity to movement of the PIR sensor can be adjusted using the Sensitivity parameter.

HINT: To assist in setting the Sensitivity, turn on the Walk Test LED which will flash red when movement is detected.

Switch Level On/Off

Occupancy detection can be made dependant on the ambient light level using the Lux On Level and Lux Off Level parameters.

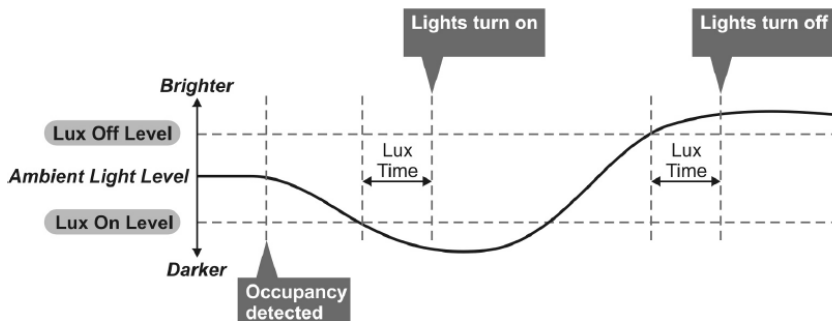

Maintained Illuminance

The detector measures the overall light level in the detection area and calculates the correct output for the luminaires, to achieve a preset lux level (maintained illuminance).

Readback function (Professional handset only)

ability to read back the settings stored in a device.

To read back individual parameters

- Navigate to the parameter and press the 'R' (Read) button whilst pointing at the device. The handset will click when the parameter has been read back, the device will flash its LED, and the value will be shown against the parameter in the menu.

To read back all of the parameters in a menu

- Press and hold the 'R' (Read) button for more than 1 second.
- The handset will click every time a parameter is received
- The device will show multiple flashes of its LED
- All of the values will be shown against the parameters in the menu.
- The individual parameters may be edited and then saved as a 'Macro'.

Notes

- If a parameter(s) has been missed because of a communication error, the missing value(s) is replaced by dashes.
- When reading back, the Channel 1 relay (where fitted) will temporarily be switched off, and will return to it's normal state 2 seconds after the read back has been completed.

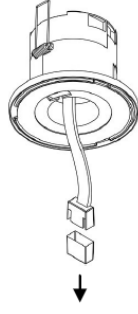
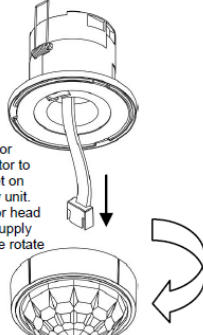



<p>Assembly</p> <p>The Highbay PIR may be supplied in two parts. Follow the instructions to assemble.</p> <p>Safety note</p> <p>Only apply power when the sensor head has been locked into position onto power supply.</p>	<p>1</p>  <p>Remove connector cover</p>	<p>2</p>  <p>Push-in sensor head connector to mating socket on power supply unit. Locate sensor head onto power supply and clockwise rotate until locked.</p>
--	---	---

designed to be mounted using either:

- Flush fixing, or
- Surface fixing, using the optional Surface Mounting Box (part no. 0041558)

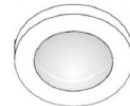
Both methods are illustrated below.

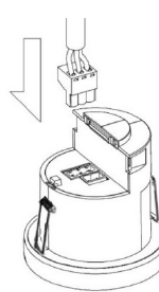
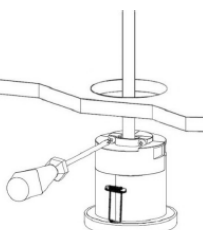
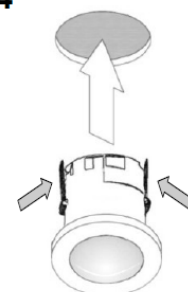
Use the supplied gasket to ensure IP rating (not compatible with Surface Mounting Box part no. 0041558)

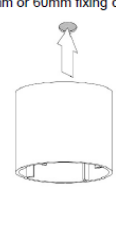
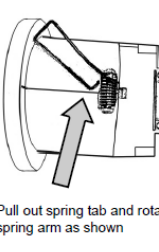
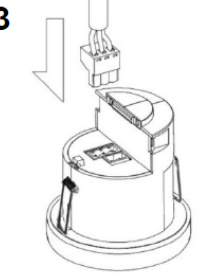
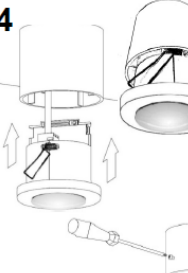
<p>Flush Fixing</p> <p>Warning - be careful bending springs when mounting unit.</p> 	<p>1</p> <p>Hole Ø64mm</p> 	<p>2</p> 	<p>3</p> 	<p>4</p> 
<p>Surface Fixing</p> 	<p>1</p> <p>50mm or 60mm fixing centres</p> 	<p>2</p>  <p>Pull out spring tab and rotate spring arm as shown</p>	<p>3</p> 	<p>4</p> 

Wire stripping details

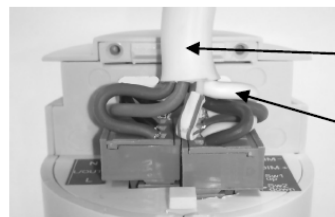
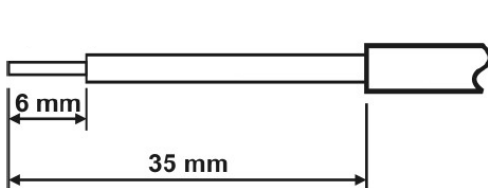

Important

Ensure that the cables are formed as shown before affixing the cable clamp. The clamp **MUST** clamp the outer sheath(s) only.

Bend cores as shown.

Burn-in

Overview

It is a requirement of many fluorescent lamp manufacturers to have the lamps on at maximum output for a period of time to guarantee lamp life (refer to the manufacturer's datasheet for details) As this Highbay PIR is able to dim the lamps using DALI/DSI, the product provides a facility to disable this for a given period of time.

Operation

By setting the "Burn in" parameter, you can select a time during which the lamps are not allowed to deviate from maximum output. The unit counts the time, and even remembers how long has elapsed in the event of a power failure. To cancel the burn in function, simply select a time of 0. Note that when the lamps are changed, the burn in time should be set again.

Wiring diagrams

Channel 1 (switched output) of the **IHighbay PIR** can either be used to switch a separate channel of standard, non-dimming luminaires, or to isolate the mains supply to dimming ballasts (saving on the standby current of the ballasts).

Multiple luminaires may be connected in parallel to Channel 1 (via the **N** and **L/Out** terminals) as long as the maximum total load is not exceeded.

Channel 2 (dimmable output) of the **IHighbay PIR** can be

used to control the light output of luminaires that are fitted with dimming ballasts/transformers.

The ballasts/transformers can be connected in parallel to Channel 2 (via the **DIM-** and **DIM+** terminals). Refer to the specification on page 12 for ballast quantities.

The wiring examples below show common methods of connecting the output channels for a single detector unit.

Single channel dimming

Functions: Switches the luminaire with occupancy and maintains illuminance. Dims and switches using optional centre biased retractive switch (MK K4900 or similar).

Configured to presence detection: Turns on automatically with occupancy. Maintains illuminance. Press and release down switch to turn off. Press and release up switch to turn back on. Press and hold up switch to dim up, press and hold down switch to dim down. Turns off after occupancy.

Configured to absence detection: Press and release up switch to turn on. Maintains illuminance. Press and release down switch to turn off. Press and hold up switch to dim up, press and hold down switch to dim down. Turns off after occupancy.

Channel mode: Set to "Switch and dim together".

Switch mode: Set to "2 position switch together".

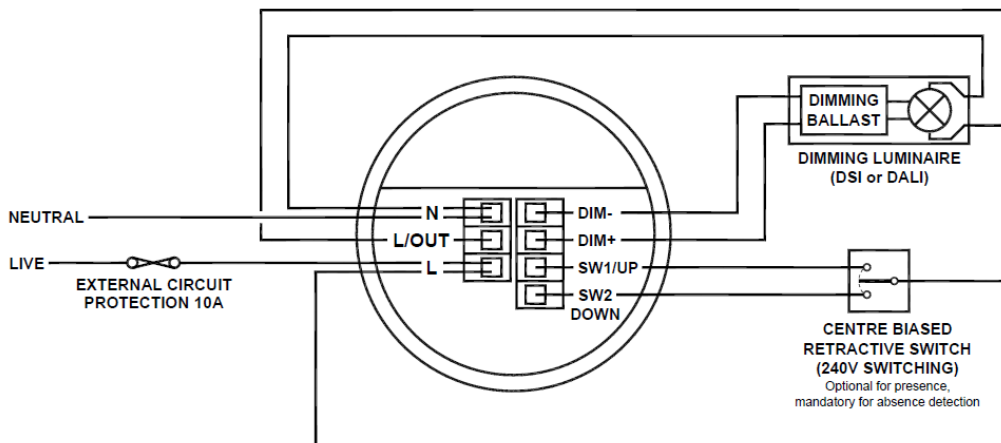

When there is a requirement to have an 'Off' state that requires a permanent dimmed level, then use the DSI / DALI "pair" to both switch and dim, and a live feed direct to the ballast. Set the 'Off value' (in the Advanced Programming section) to a value greater than zero to achieve a permanent dimmed level for the 'Off' state. See the diagram below for wiring details.

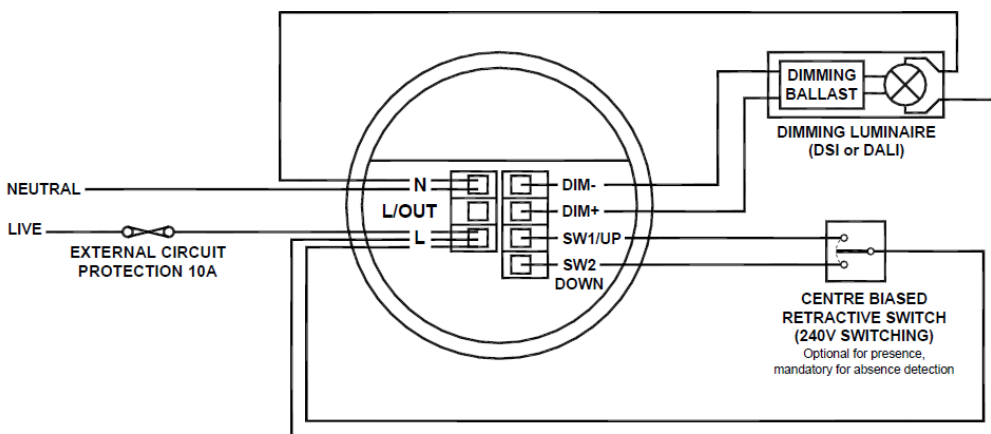

Two channel, individual switches

Functions: Switches both channels with occupancy. Maintains illuminance, dims and switches the dimming channel using optional single position retractive switch (switch 2). Switches the switching channel using the optional single position retractive switch (switch 1).

Configured to presence detection: Turns on automatically with occupancy. Maintains illuminance (dimming channel only). Press and release switch to toggle output. Press and hold switch to dim up and down (reverses direction with each press). Turns off after occupancy.

Configured to absence detection: Press and release switch to turn on. Maintains illuminance (dimming channel only). Press and release switch to turn off. Press and hold switch to dim up and down (reverses direction with each press). Turns off after occupancy.

Channel mode: Set to "Switch and dim separate"

Switch mode: Set to "1 position switch separate"

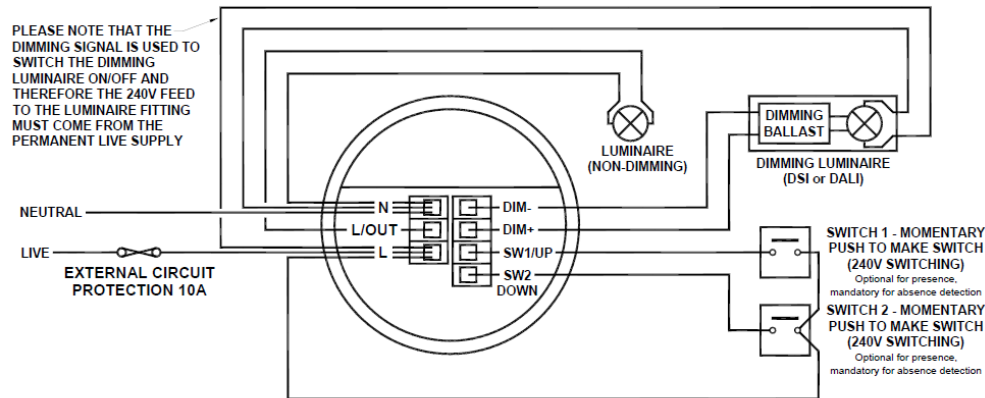

Two channel, single switch

Functions: Switches both channels with occupancy. Maintains illuminance, dims and switches the dimming channel using optional centre biased retractive switch.

Configured to presence detection: Turns on automatically with occupancy. Maintains illuminance (dimming channel only). Press and release down switch to turn off. Press and release up switch to turn back on. Press and hold up switch to dim up, press and hold down switch to dim down. Turns off after occupancy. Channel 1 does not operate with switch.

Configured to absence detection: Press and release up switch to turn on. Maintains illuminance (dimming channel only). Press and release down switch to turn off. Press and hold up switch to dim up, press and hold down switch to dim down. Turns off after occupancy. Channel 1 does not operate with switch.

Channel mode: Set to "Switch and dim separate"

Switch mode: Set to "2 position switch separate"

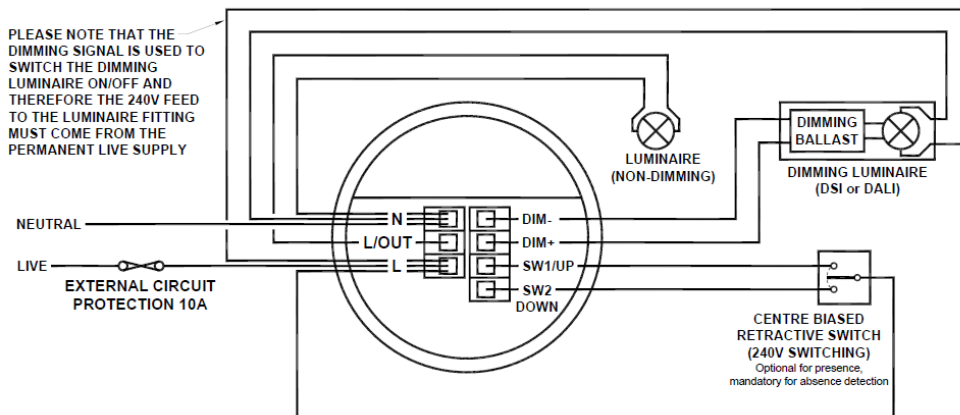

PLEASE NOTE THAT THE CENTRE BIASED RETRACTIVE SWITCH WILL PROVIDE CONTROL FOR THE DIMMING LUMINAIRE(S) ONLY. THE NON-DIMMING LUMINAIRE(S) WILL BE CONTROLLED ONLY BY THE SENSOR

Wiring diagrams (cont.)

Single channel switching

Functions: Switches channel 1 only with occupancy, optional override switch. No dimming output.

Configured to presence detection: Turns on automatically with occupancy. Press and release down switch to turn off. Press and release up switch to turn on. Turns off after occupancy.

Configured to absence detection: Press and release up switch to turn on. Press and release down switch to turn off. Turns off after occupancy.

Channel mode: Set to "Switch only"

Switch mode: Set to "2 position switch together". Note: a single position switch can be used instead to toggle the output, set to "1 position switch separate".

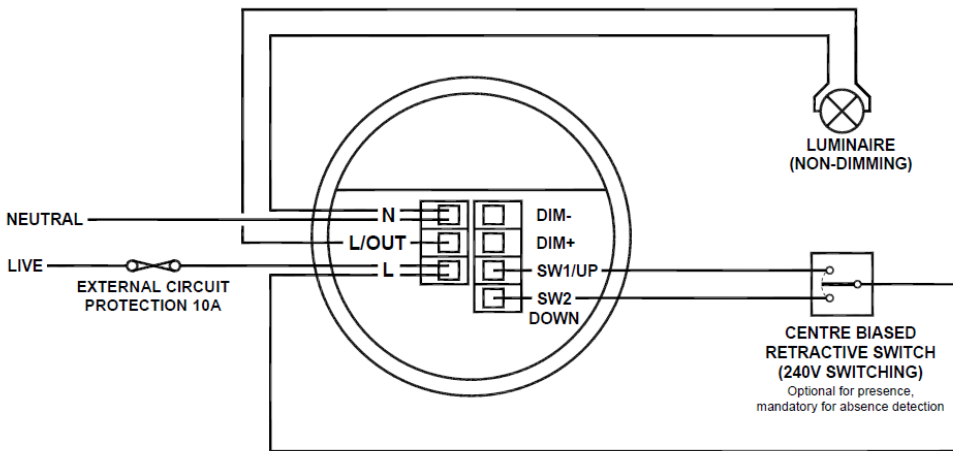

Power-up test procedure

When power is applied to the unit, the load will turn on immediately.

Set the timeout to 10 seconds, vacate the room or remain very still and wait for the load to switch off .

Check that the load switches on when movement is detected.

The unit is now ready for programming.

Fault finding

What if the load does not turn ON?

- Check that the live supply to the circuit is good.
- Check that the load is functioning by bypassing the sensor (e.g. link terminals **L** and **L/ Out** on Channel1).
- If the detection range is smaller than expected, check the diagrams on page 2. Rotating the sensor slightly may improve the detection range.

HINT: *The Walk Test LED function can be used to check that the unit is detecting movement in the required area.*

What if the load does not turn OFF?

- Ensure that the area is left unoccupied for longer than the Time Out Period.
- Ensure that the sensor is not adjacent to circulating air, heaters or lamps.

Basic programming

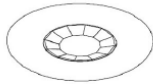

The functionality of the **Highbay PIR** is controlled by a number of parameters which can be changed or programmed by any of the following devices:

- **0041546** Infrared Handset. See below for programmable functions.
 - **0041562** Infrared Handset (with LCD). See user guide for full programming details.
- For most basic programming operations the 0041546 handset can be used and the following procedures are based on using this device.

Point the handset at the Sensor and send the required programming commands to the unit as shown below.

Valid commands will be indicated by a red LED flash. See page 1 for details of other LED responses.
Note: other functions on the 0041546 which are not shown below are not applicable to this product.

Parameter Name	Default Value	Number of Shift key presses				UHS5 Handset Graphics	Description
		0 <small>SHIFT 1 SHIFT 2</small>	1 <small>SHIFT 1 SHIFT 2</small>	2 <small>SHIFT 1 SHIFT 2</small>	3 <small>SHIFT 1 SHIFT 2</small>		
Button Activation							
On / Raise		On	Raise				Turn lights on or to raise lights.
Off / Lower		Off	Lower				Turn lights off or to lower lights.
Walk test	Off	On	Off				When set to On this causes a red LED to flash on the sensor when it detects movement. Use this feature to check for adequate sensitivity levels.
Time Out (Time adjustment)	20 mins	1, 10 & 20 minutes	5, 15 & 30 minutes	10 seconds			Once the detector is turned on, this value sets how long the lights will stay on once movement has ceased.
Lux on level (Switch level on)	9	2, 5 & 7	4, 6 & 9				Lux level setting to prevent the luminaires being switched on if the ambient light level is sufficient (adjustable between 1 and 9). The luminaires will always be switched on at level 9.
Light Level	6 (600)			2 (200) 5 (500) 7 (700)	4 (400) 6 (600) 9 (999)		Sets a target light level to be maintained by the lighting system. 9 (999) = disabled.
Lux off level (Switch level off)	9	2, 5 & 7	4, 6 & 9				Lux level setting to switch the luminaires off during occupancy if the ambient light level goes above the setting (adjustable between 1 and 9). Level 9 will always keep the lights on. This setting can be used for "window row switching". <i>Note: the Lux Off Level value must always be greater than the Lux On Level value.</i>
Load Type	DALI			2-DALI 7-DSI	2-DALI on		Sets the ballast control protocol to be used by the output channel.
Sensitivity	9	1, 5 & 9	3, 6 & 8				Sensitivity level for detecting movement. 1 = low sensitivity 9 = high sensitivity
Defaults				D			Returns the unit to the default settings.
Burn-in	0	0	50	100			Determines how long the output will be at 100% so that lamps 'burn-in'. The 'burn-in' time is not affected by power supply interruptions.
Presence / Absence	Presence	Presence	Absence				Presence mode allows the output to turn on when movement is detected and off when movement ceases. Absence mode allows the output to turn off when movement ceases, but must be manually turned on first.
Shift							Use this button to select the settings in red and blue signified by the 'Shift 1' and 'Shift 2' LEDs

Advanced programming

Parameter Name	Default Value	Range / Options	Description	0041546	0041562
Detector Parameters					
Walk Test LED	Off	On or Off	When set to On this causes a red LED to flash on the sensor when it detects movement. Use this feature to check for adequate sensitivity levels.	✓	✓
Time Out (Time adjustment)	20 minutes	0-99 minutes	Once the detector is turned on, this value sets how long the lights will stay on once movement has ceased. Select 0 for 10 second delay – use for commissioning only.	✓	✓
Manual Time Out	10 minutes	0-99 minutes	When a manual operation occurs, either via the switch input or the infrared, it invokes the timeout period. Example 1: a detector in presence mode has a detector timeout of 15 minutes and a manual timeout of 3 minutes. When the user leaves the room they press the off button. The sensor will revert to automatic after 3 minutes, and then walking back in the room will turn the lights on. Example 2: using the settings above, the user turns the lights off (say for a presentation) but stays in the room. Every time a movement is detected, the manual timeout period is re-triggered, but when it doesn't pick up for the short timeout period, the sensor will timeout and revert to automatic. This means the lights may turn on inadvertently during the presentation, if the occupants are still for the manual timeout period, so adjust the timing carefully.	✗	✓
Sensitivity On	9	1 (min) to 9 (max)	Sensitivity level for detecting movement when the detector is already on. 0041546 sets Sensitivity On and Off to the same value.	✓*	✓
Sensitivity Off	9	1 (min) to 9 (max)	Sensitivity level for detecting movement when the detector is off. 0041546 Sensitivity On and Off to the same value.	✓*	✓
Lux time	0	0 (disabled) 1-99 minutes	If the detector measures the lux level and decides that the output needs switching on or off as a consequence, the lux time must elapse first. If at any time during the timed delay the lux change reverses then the process is cancelled. Lux Time enables absence detection to be implemented with a lux off level set. When the button is pressed, the lights will go on, regardless of ambient light level. However, if there is sufficient ambient light, they will turn off again after the Lux Time. <i>Note that whenever the an external switch is pressed, whether in absence or presence mode, if the lights were out because of the lux level, they will be immediately turned on again for at least the Lux Time.</i>	✗	✓
Power Up State	On	On or Off	Select No for a 30 second delay on start up. If Yes is selected, there will be no delay on start up and the detector will always power up detecting.	✗	✓
Disable Detector	N	Y or N	Disables detection, leaving the relay output permanently off with the dimming output operational. This mode is used when the unit is for maintained illuminance only.	✗	✓
On Delay	0 minutes	0-99 minutes	The On Delay to allows the first channel to switch on after the second channel. A typical application for this would be where a detector is controlling lighting and air conditioning in an area. When the occupant is detected, the lighting will be turned on immediately, whereas the air conditioning may be turned on after 15 minutes. If the area is vacated and the detector times out before the delay, then the air conditioning would never go on. The delay can be set only for channel 1 using the on delay parameter.	✗	✓
Inhibit	4 seconds	1 to 999 seconds	When the detector turns off, a delay is instigated to prevent retriggering. In certain circumstances this delay may not be enough. This parameter allows the delay to be changed.	✗	✓
Verify	N	Y or N	Requires two or more PIR detectors to detect to trigger the lights on.	✗	✓
Factory default	-	-	Restores factory default settings	✓	✓

Channel Modes					
Switch only	-	-	Usually used for absence detection - in this mode the dimming channel is not used.	✗	✓
Switch and dim together	Default	-	The detector will switch and dim the lighting together.	✗	✓
Switch and dim separate	-	-	Provides 2 channel operation – Channel 1 is switched via the relay output, and Channel 2 is dimmed / switched via the dimming output.	✗	✓

User Modes					
Raise	-	-	Increase light level. Reverts when occupancy cycle complete.	✓	✓
Lower	-	-	Decrease light level. Reverts when occupancy cycle complete.	✓	✓
Scene up	-	-	Steps up between 6 pre-defined scenes.	✗	✓
Scene down	-	-	Steps down between 6 pre-defined scenes.	✗	✓
Scene #	-	-	Select the individual scene, between 0 and 6. (1 = min. output; 2 = 10%; 3 = 25%; 4 = 50%; 5 = 75%; 6 = 100%)	✗	✓
Override On	-	-	If the lights are off, sending the IR command will turn them on immediately and revert to automatic operation using the manual timeout period.	✓	✓
Override Off	-	-	If the lights are on, sending the IR command will turn them off immediately. After the manual timeout period (described above), the sensor will revert to automatic.	✓	✓
Cancel	-	-	Cancels the on or off override, returning the detector to normal operation.	✗	✓

Advanced programming

Parameter Name	Default Value	Range / Options	Description	0041546	0041562
Channel 1 –Switching Channel					
Detection Mode	Presence	Presence or Absence	Presence mode allows the output to turn on when movement is detected and off when movement ceases. Absence mode allows the output to turn off when movement ceases, but must be manually turned on first.	✓	✓
Lux on level (Switch level on)	9	1 to 9 For a higher resolution a scale of 101-199 is available	Sets a minimum light level below which the PIR sensor is enabled, allowing lights to be turned on by movement. <i>Note: the Lux Level Off value must always be greater than the Lux Level On value.</i>	✓	✓
Lux off level (Switch level off)	9	1 to 9 For a higher resolution a scale of 101-199 is available	Sets a maximum light level above which the PIR sensor is disabled, preventing lights from being turned on by movement.	✓	✓

Channel 2 -Dimming Channel					
Detection Mode	Presence	Presence or Absence	Presence mode allows the output to turn on when movement is detected and off when movement ceases. Absence mode allows the output to turn off when movement ceases, but must be manually turned on first.	✓	✓
Lux on level (Switch level on)	9	1 to 9 For a higher resolution a scale of 101-199 is available	Sets a minimum light level below which the PIR sensor is enabled, allowing lights to be turned on by movement. <i>Note: the Lux Level Off value must always be greater than the Lux Level On value.</i>	✓	✓
Lux off level (Switch level off)	9	1 to 9 For a higher resolution a scale of 101-199 is available	Sets a maximum light level above which the PIR sensor is disabled, preventing lights from being turned on by movement.	✓	✓
Light Level (maintained illuminance)	600	1 to 998 (999 disabled)	Sets a target light level to be maintained by the lighting system.	✓	✓
Load Type	DALI	DSI DALI DALI On	Sets the ballast control protocol to DSI. Sets the ballast control protocol to DALI. DALI On provides a permanent voltage to DALI ballasts when DALI has not been implemented correctly in the ballast. Maximum number of ballasts is 5 unless the relay is disabled then it is 10.	✓ ✓ ✗	✓ ✓ ✓
Max Value	100%	0 to 100%	Maximum dimming output level.	✗	✓
Min Value	0%	0 to 100%	Minimum dimming output level.	✗	✓
Memorise	N	Yes or No	If this is set to Yes, the last manual lux level set will be memorised and used as the new switch on level.	✗	✓
On value	99	0 to 99	Dimming output level when switched on (0-99).	✗	✓
Off value	0	0 to 99	Dimming output level when switched off (0-99). If a non-zero off value is set, then the output will toggle between this value and completely off depending on the switch level on and off values. For example, if it is light outside, the fittings will be off if there is no occupancy. If it is dark outside, they will adopt the preset off value. This feature is only enabled if 'Min value' is set to 99.	✗	✓
Burn-in	0	0 (disabled) or 1 to 999 hours	Determines how long the output will be at 100% so that lamps 'burn -in'. The 'burn-in' time is not affected by power supply interruptions.	✓	✓
Fade value	10	0 to 99	After occupancy ceases, this dimming output level is loaded for the fade time (adjustable between 0 and 99).	✗	✓
Fade mins	0	0 to 99	This is the time period (adjustable between 0 and 99 minutes) that the luminaire will be held at the fade value before turning off. A value of 0 disables the fade function.	✗	✓
Speed On	40	Measured in 0.1 sec intervals.	Determines the dimming response speed after the setup time has finished.	✗	✓
Speed Set	5	Measured in 0.1 sec intervals.	Determines the dimming response speed during the set up time. Measured in 0.1 sec intervals. If set to 0 will disable dimming for "Set seconds" below, used if fittings are required to warm up before dimming.	✗	✓
Set Seconds	120	1 to 999 seconds	Determines how long the dimming response set-up period lasts on power-up or on setting change. This enables the desired lux level to be achieved rapidly when the lights come on, or during setup.	✗	✓

Switch Modes					
2 position switch together	Default	-	A single centre biased retractive switch will be used to control both channels together.	✗	✓
2 position switch separate	-	-	A single centre biased retractive switch will be used to control only the dimming channel.	✗	✓
1 position switch together	-	-	A single position retractive switch controls both channels together.	✗	✓
1 position switch separate	-	-	Two single position retractive switches, controlling the channels separately.	✗	✓

Technical data

Dimensions	See diagrams opposite
Weight	0.2kg complete unit
Supply Voltage	230VAC +/- 10%
Frequency	50Hz
Circuit protection	10A
Highbay PIR	
Maximum Load	<p><i>Channel 1 (switching):</i> 10A of lighting and/or ventilation including incandescent, fluorescent, compact fluorescent, low voltage (by switching the primary of transformer).</p> <p><i>Channel 2 (dimming):</i> Maximum number of DSI or DALI ballasts is 10 unless the relay is disabled then it is 20.</p>
Power consumption	On 800mW, Off 299mW
EBDHS-PSU-DD	
Maximum Load	<p><i>Channel 1 Not fitted</i></p> <p><i>Channel 2 (dimming):</i> Maximum number of DSI or DALI ballasts is 20.</p>
Power consumption	On 844mW, Off 847mW
Dimming output	Basic insulation only. Although low voltage, this is not an SELV output and should be treated as if mains potential. Use mains rated wiring.
Terminal Capacity	2.5mm ²
Temperature	Highbay PIR -10°C to 35°C
Humidity	5 to 95% non-condensing

Material (casing)	Flame retardant ABS and PC/ABS
Type	Class 2
IP rating	40 without gasket. 65 with gasket.
Compliance	EMC-2004/108/EC LVD-2006/95/EC



Highbay PIR

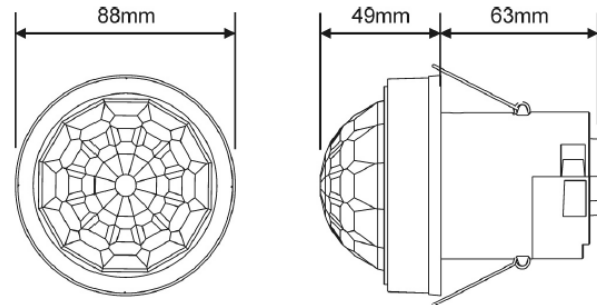

DBB

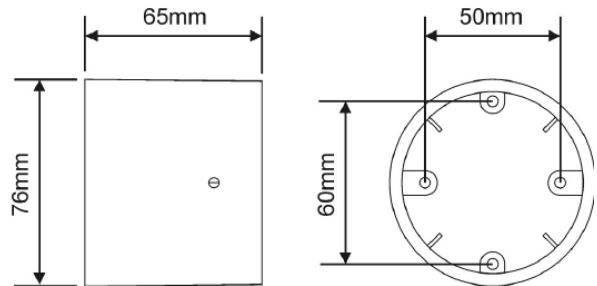

UK and international patents applied for

Using the 0041562 – Please use EBDHS menu to configure