

Microwave detectors - wall-mounted

Zone 3: France, Portugal & Switzerland



FEATURES

- Up to 30m detection
- Low numbers of detectors required to cover a large area
- Dual sensitivity: independently configurable ON and OFF motion sensitivity
- Adjustable time delay (15 seconds - 30 minutes)
- Holds load on until occupant is no longer detected
- Self contained
- No external control boxes, minimises installation time
- IP66 version also available
- Box accessory enables surface mounting
- Can also control heating and ventilation loads
- Multiple units can be used in parallel to cover areas such as 'L shaped' corridors



0041567*



0041569*

ORDER CODE	DESCRIPTION	LOAD RATING AT 230VAC	
		R/I/F & CF	TIME DELAY
Occupancy-linked detectors with lux level sensing			
0041567*	Microwave occupancy detector with lux level sensing and time delay function	10A	15 sec to 30 min
0041569*	As 0041567*, plus suitable for damp environments (IP66) rating	10A	15 sec to 30 min

ACCESSORIES	DESCRIPTION
0041546	Handheld programming device
0041558	Surface mounting back box
0051562	Programming handset for lux level sensing and dimming detectors
0041594	Surface mounting back box extender ring
0041638	User handset override on/off; lux up/lux down (lux level sensing & dimming models)

R = Resistive; I = Incandescent; Fluorescent; CF = Compact Fluorescent



0041546



0041558



0041594



0041638



0041638

Dimensions (mm)

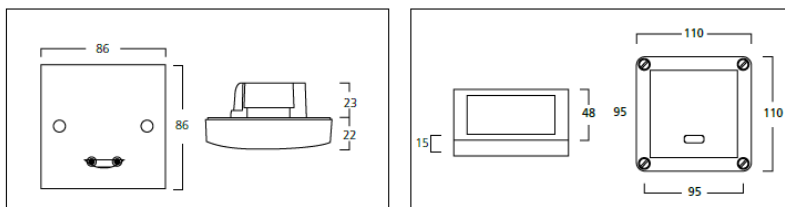

Detection pattern

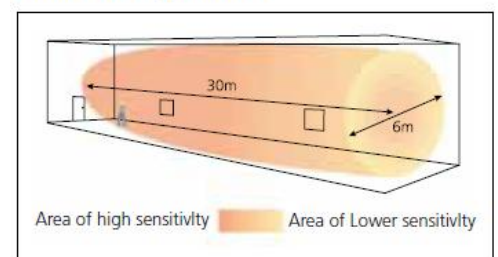

Features

Fig 1: Front features

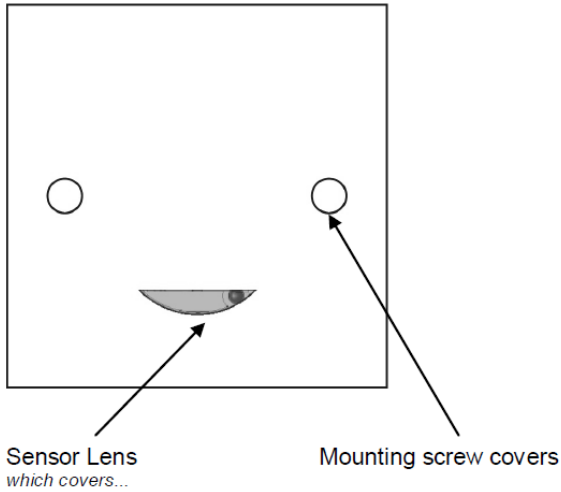

IR Receiver
Light Level Sensor
Status LED

Microwave Sensor

Detects movement within the unit's detection range, allowing load control in response to changes in occupancy.

IR Receiver

Receives control and programming commands from an IR (infrared) handset.

Light Level Sensor

An integral adjustable photocell allows the lights to be kept off if there is sufficient ambient light.

Presence detection

When movement is detected the load will automatically turn on. When the area is no longer occupied the load will automatically switch off after an adjustable time period.

Status LED

The LED flashes **Red** to indicate the following:

Walk Test LED active	 when movement is detected
Valid setting received	

Installation

Back box Compatibility

Designed to fit both UK and EU style back boxes

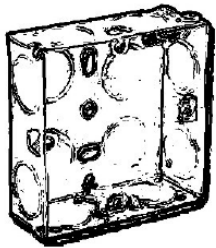

BS4662 square back box

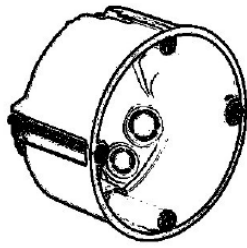

DIN standard round back box

Mounting

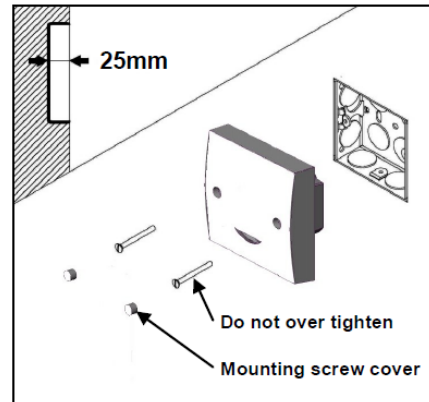

Wiring

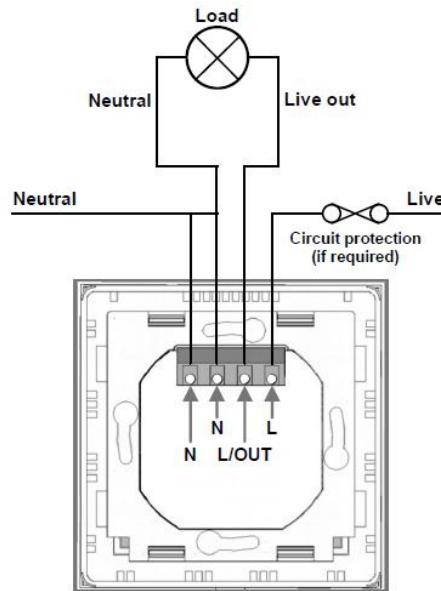

To switch from more than one position simply wire two or more units in parallel to achieve two way and intermediate switching.

The detector should be sited so that the occupants of the room fall inside the detection pattern shown overleaf, at a recommended height of 2.8m for ceiling mounted sensors. Note that the higher the sensor is installed the shorter the detection range will be.

- Do not site within 1m of any lighting or ventilation equipment.
- Do not fix to a vibrating surface.
- Site as far away as possible from the surface of metal objects.

Fault finding

What if the load does not turn ON?

- Strap across the L and LIVE OUT terminal to turn the load on
- If the supply and wiring are good, check the LUX level setting. Increase the LUX level setting to allow the controller to turn on at higher ambient natural light level.

What if the load does not turn OFF?

- Ensure that the area is left unoccupied for a greater time period than the time out period set using the switch.
- Make sure that the sensor is not adjacent to vibrating surfaces or objects (e.g. ventilation equipment).
- The unit may pick up movement through thin partitions or ceilings. Reduce the sensitivity.

Programming

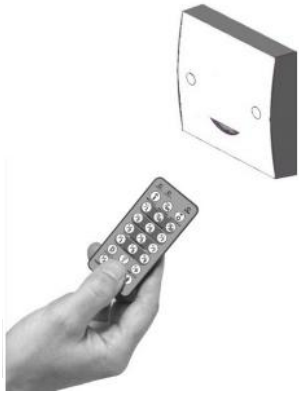

The functionality of the **0041567** is controlled by a number of parameters which can be changed or programmed by any of the following devices:

- **Basic Programmer handset 0041546** – See instructions below
- **Professional Programmer handset - 0041562** See user guide for full programming details.









For most basic programming operations the UHS5 handset can be used and the following procedures are based on using this device.

Point the handset at the Sensor and send the required programming commands to the unit as shown below.

Valid commands will be indicated by a red LED flash. See page 1 for details of other LED responses.

Note: other functions on the 0041546 which are not shown below are not applicable to this product.

 **Number of Shift key presses**

Parameter Name	Default Value	Number of Shift key presses				UHS5 Handset Graphics	Description
		0 <small>SHIFT 1 SHIFT 2</small>	1 <small>SHIFT 1 SHIFT 2</small>	2 <small>SHIFT 1 SHIFT 2</small>	3 <small>SHIFT 1 SHIFT 2</small>		
Button Activation							
On / Raise	On						Turn lights on.
Off / Lower	Off						Turn lights off.
Walk test	Off	On	Off				When set to On this causes a red LED to flash on the sensor when it detects movement. Use this feature to check for adequate sensitivity levels.
Time Out (Time adjustment)	10 mins	1, 10 & 20 minutes	5, 15 & 30 minutes				Once the detector is turned on, this value sets how long the lights will stay on once movement has ceased.
Lux on level (Switch level on)	9	2, 5 & 7	4, 6 & 9				Lux level setting to prevent the luminaires being switched on if the ambient light level is sufficient (adjustable between 1 and 9). The luminaires will always be switched on at level 9.
Lux off level (Switch level off)	9	2, 5 & 7	4, 6 & 9				Lux level setting to switch the luminaires off during occupancy if the ambient light level goes above the setting (adjustable between 1 and 9). Level 9 will always keep the lights on. This setting can be used for "window row switching".
Sensitivity	9	1, 5 & 9	3, 6 & 8				Sensitivity level for detecting movement. 1 = low sensitivity 9 = high sensitivity
Defaults				D			Returns the unit to the default settings.
Shift							Use this button to select the settings in red and blue signified by the 'Shift 1' and 'Shift 2' LEDs

Detection pattern

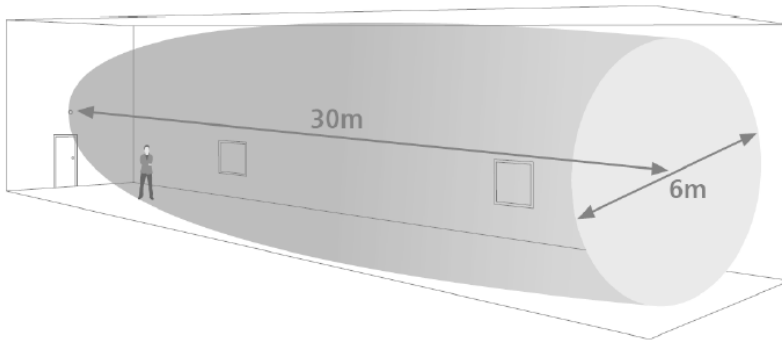

Area of high sensitivity  Area of lower sensitivity 

Dimensions

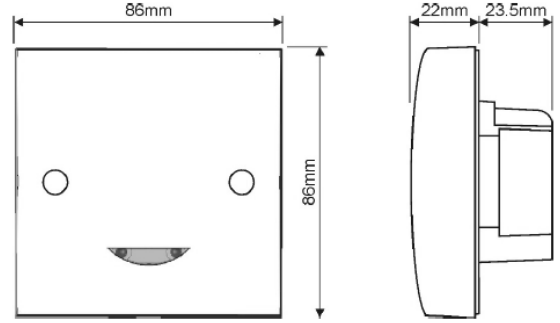

Technical data

Supply Voltage	230VAC +/- 10%
Frequency	50Hz
Power consumption	On 1.15W Off 790mW
Load	10A of lighting and or ventilation including incandescent, fluorescent, compact fluorescent, low voltage (switch primary of transformer).
Weight	0.1kg
Terminal Capacity	2.5mm ²
Time out period	Adjustable 10 seconds to 99 minutes.
Light level	Optional adjustment by using IR programming handsets.
Fixing method	Surface fixing 35mm deep plastic surface mount moulded box. Flush fixing 25mm steel backbox or 25mm deep cavity backbox.
Temperature	-10°C to 35°C
Humidity	5 to 95% non-condensing
Material (casing)	Flame retardant ABS Type Class 2
Compliance	EMC-2004/108/EC  LVD-2006/95/EC
Safety	The microwave radiation emitted by these units is extremely low power. At a distance of > 50mm the power density is <6% of the ANSI IEEE C95.1 –1991 recommended microwave power density. At a distance of 5mm from the unit it is <84% of recommended power density.

Frequency compatibility

The allowable frequency of operation of this product is different depending on region. Please select the correct order code using the table below.

Zone	Region	Frequency
Blank (1)	UK, China, India, Middle East, Malaysia, Hong Kong, Singapore	10.687GHz
2	Australia and all of Europe <i>except</i> : UK, France, Portugal, Germany, Switzerland, Austria, Slovak Republic, Republic of Ireland	10.525GHz
3	France, Portugal, Switzerland	9.900GHz
4	Germany, Austria, Slovak Republic	9.350GHz
5	Republic of Ireland	10.41GHz