

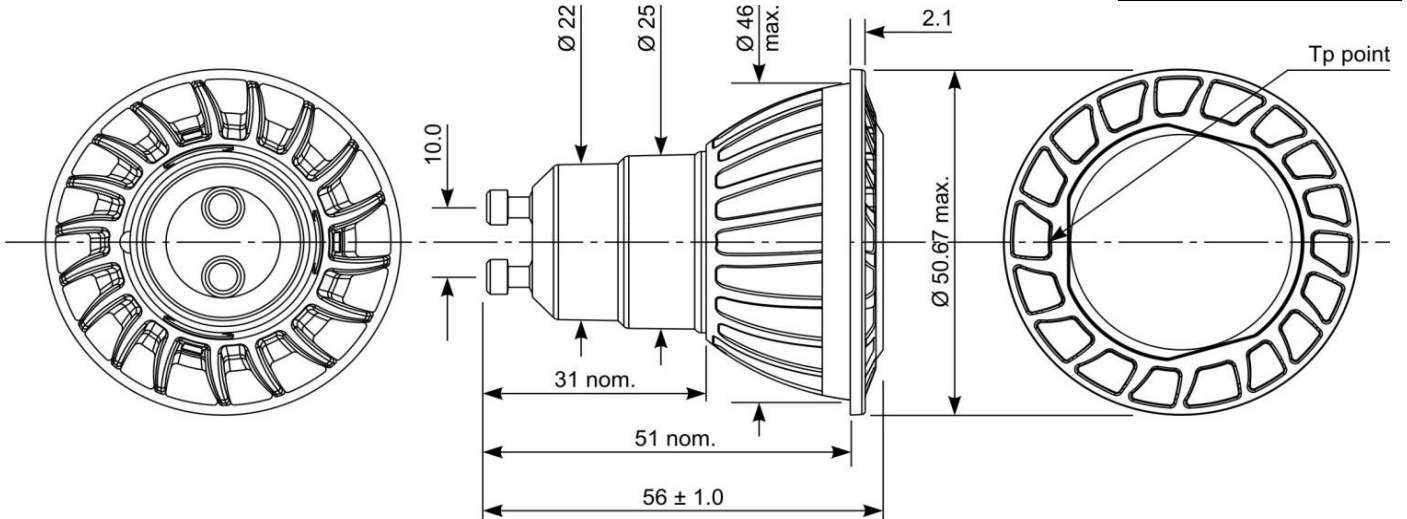

**DIMENSIONS (mm):**

Energy Class : **A+**



Bulb type : PAR16

Cap type : GU10

Finish : Dark Silver

Light Colour : 830 Warm White

**ELECTRICAL DATA:**

		<b>RATED</b>	<b>MIN.</b>	<b>MAX.</b>
Lamp Wattage	(W) :	6.5	-	7.5
Lamp Voltage	(V) :	230	198	254
Lamp Current	(mA) :	35		
Power Factor	(λ) :	0.8	0.72	-
Supply Frequency	(Hz) :	50 / 60		
Energy Consumption per 1000h	(kW/h) :	6.5		

**PHOTOMETRIC DATA:**

Beam Angle	(°) :	40	30	50
Luminous Intensity	(cd) :	1100	825	1375
Useful Luminous Flux	(lm) :	525	473	-
Useful Luminous Efficacy	(lm/W) :	81		
Correlated Colour Temperature	(K) :	3000		
Colour Rendering Index	(Ra) :	80	77	-
Red Colour Rendition	(R9) :	15		
Chromaticity Co-ordinates	(x,y) :	CCx=0.433 CCy=0.400	6-step MacAdam Ellipse	

**OPERATING CONDITIONS:**

Ta Ambient temperature range	(°C) :	25	-20	70
Tp Point	(°C) :	75	-	110
Starting Time	(s) :	-	-	<0.5
Warm-up Time to >95% Flux	(s) :	-	-	<1.0
Burning Position	:	Universal		
External Control Gear type	:	None		

**LAMP LIFE:**

Average Life (L <sub>70F50</sub> )	(h) :	25 000
Switching Cycles	(#) :	100 000

**APPLICATION:** General lighting. Adaptive thermal control maintains lifetime in enclosed luminaires. Broad compatibility with dimmer switches / electronic timers / electronic switches. Complies with IEC62560, IEC62612, IEC62471, IEC61547, IEC61000, EN55015, EN62493.

Issued by : TIENEN

Revision date : 27-X-2015

**DATA SHEET**

Specification No. : 70-R16-0026657/A

Page : 1 of 2

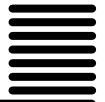

**PHOTOMETRIC GRAPHICS:**

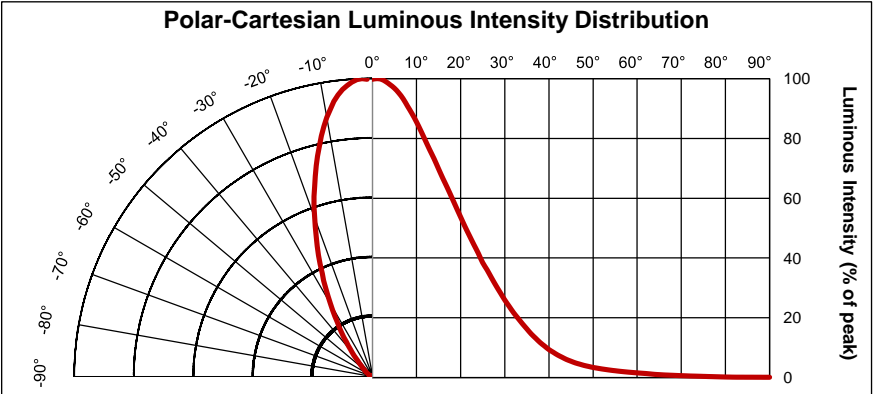
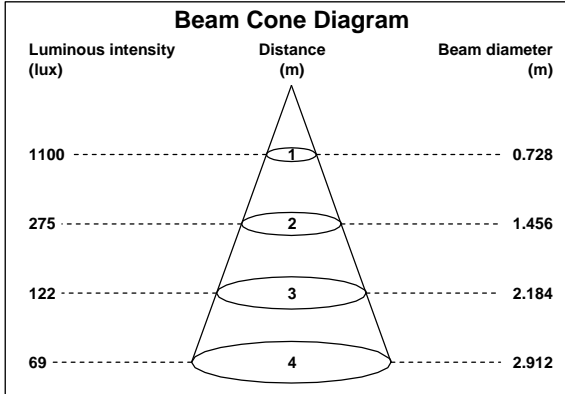

**SPECTRAL GRAPHICS:**

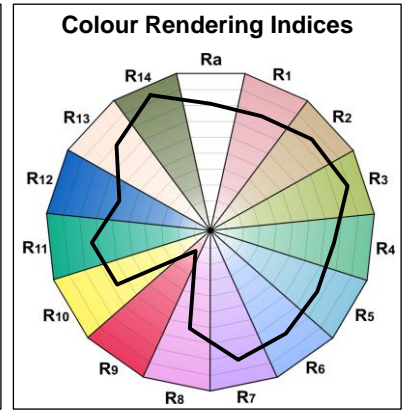
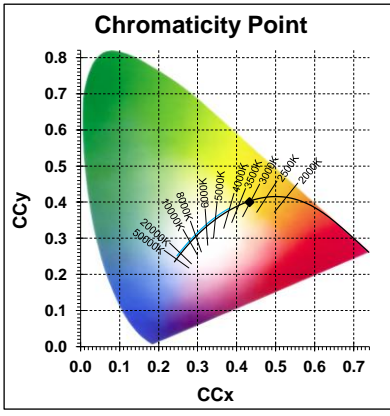
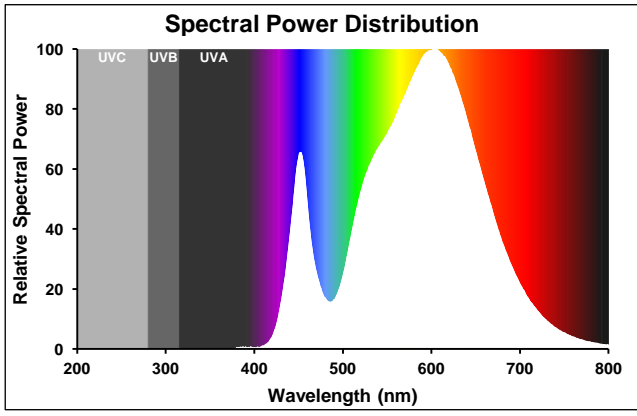

**PERFORMANCE GRAPHICS:**

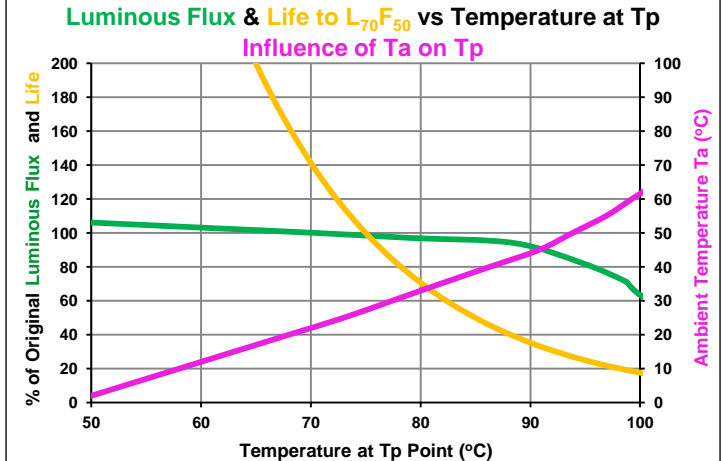
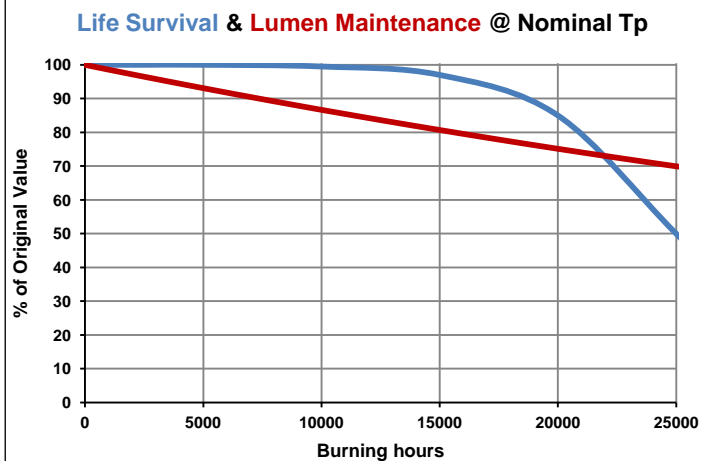

Issued by : TIENEN  
Revision date : 27-X-2015

**DATA SHEET**

Specification No. : 70-R16-0026657/A  
Page : 2 of 2

